

ACO Modular

M125 och M200

Modulrännor för storkök och industri





ACO

ACO har mångårig erfarenhet av byggbranschen både i Sverige och i hela världen. Vi finns i över 50 länder och har egen utveckling och egna fabriker. Idag är vi över 5 300 anställda och uppnådde 2022 en omsättning på över 1 miljard Euro.

Innehåll

Vilken ränna är bäst för mig?	4
ACO Modular M125	6
Rännor	7
Brunnsunderdelar	14
Galler för rännor	18
Galler 300 x 300 mm till brunnsöverdelar	23
Tillval för Modular M125	25
ACO Modular M200	30
Rännor	31
Brunnsunderdelar	37
Galler till rännor	39
Galler 300 x 300 mm till brunnsöverdelar	43
Tillval till Modular M200	45
Specialanpassad ränna	48
Egendesignat galler	49

Vilken ränna är bäst för mig?

1 Välj stålqualität

- Rostfritt stål, 1.4301
- Rostfritt syrafast stål, 1.4404

2 Välj storlek bredd på ränna

- Modular M125 (125 mm)
- Modular M200 (200 mm)

3 Välj antal utlopp och utloppsriktning/ar

- Sidoutlopp
- Bottenutlopp
- Ändplacerad

4 Välj dimension på utlopp

- Ø75 mm
- Ø110 mm

5 Välj galler

- Belastningklass L15–C250
- Gallermodell/gallertyp

6 Välj tillval/reservdelar

- Vattenlås
- Ingjutningsskydd
- Silkorg
- Gallerkrok
- Sandfång
- Radontätning

7 Lägg beställning

- order@aco-nordic.se



ACO Modular M125

ACO Modul-serien är rostfria rännor som är avsedda för kommersiella och industriella applikationer med fokus på livslängd och funktion.

V-formad rännbotten medför ökad flödes hastighet vid låga flöden och bättre självreningseffekt.

- Kompatibelt med EN 1253
- Testad och godkänd enligt EN 1433
- Finns i rostfritt stål EN 1.430 och rostfritt syrafast stål EN 1.4404
- Betad
- Teleskopisk lösning med brunn
- Brett gallersortiment upp till C 250 (EN 1433)
- Kan beställas i specialanpassad längd, se sid. 48
- Kan beställas med egendesignade galler, se sid. 49

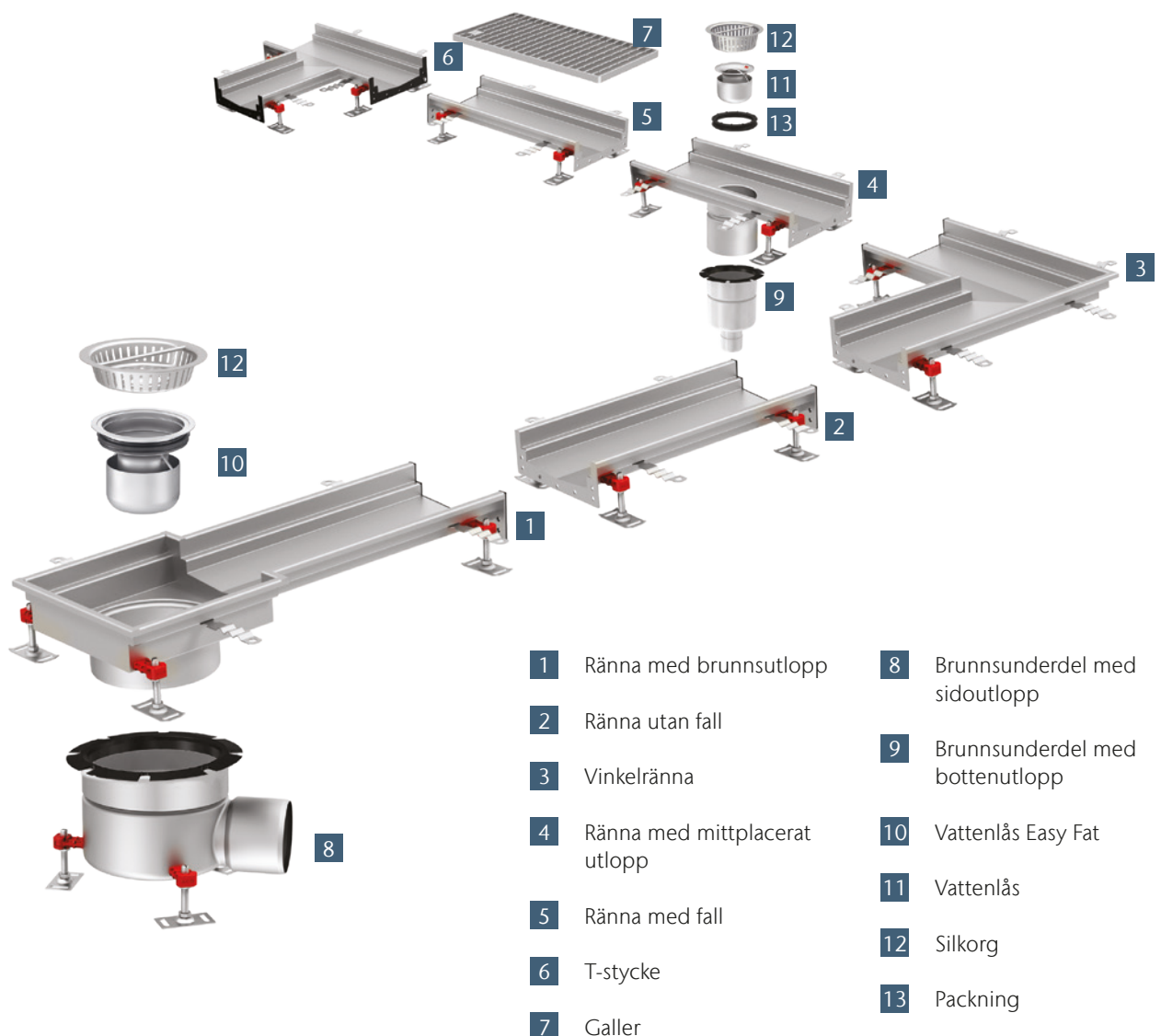

Rännor

Ränna utan fall

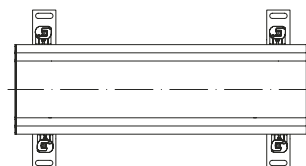
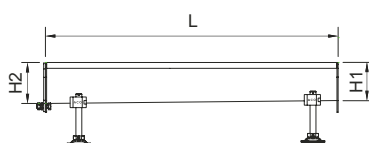
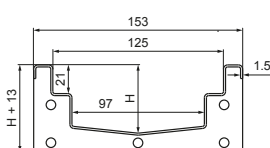
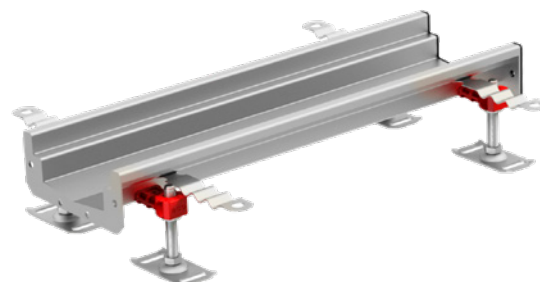

Dimension		Artikelnr.	
L	H	1.4301	1.4404
[mm]	[mm]		
500	50	105119	407211
	65	105120	407212
	80	105121	407213
	95	105122	407214
	110	105123	407215
	125	105124	407216
1000	50	105127	407217
	65	105128	407218
	80	105129	407219
	95	105130	407220
	110	105131	407221
	125	105132	407222
2000	50	105135	407223
	65	105136	407224
	80	105137	407225
	95	105138	407226
	110	105139	407227
	125	105140	407228
3000	50	105143	407229
	65	105144	407230
	80	105145	407231
	95	105146	407232
	110	105147	407233
	125	105148	407234

Ränna med fall

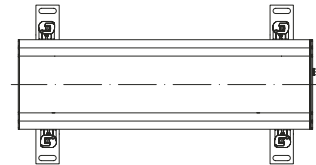
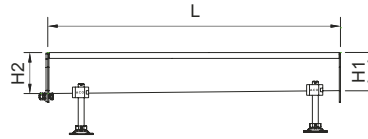
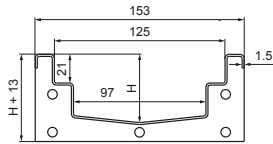
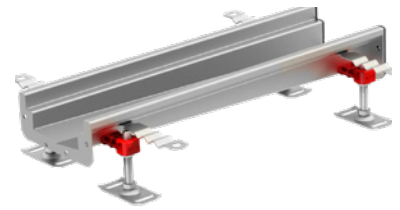

L	Dimension			Artikelnr.	
	[mm]	H1 [mm]	H2 [mm]	1.4301	1.4404
500		50	65	105151	407235
		65	80	105152	407236
1000		50	65	105155	407237
		65	80	105156	407238
		80	95	105157	407239
		95	110	105158	407240
2000		50	65	105161	407241
		65	80	105162	407242
		80	95	105163	407243
		95	110	105164	407244
3000		110	125	105165	407245
		50	65	105168	407246
		65	80	105169	407247
		80	95	105170	407248
		95	110	105171	407249
6000		110	125	105172	407250
		50	80	408821	408824
		65	95	408822	408825
	95	125	408823	408826	

Info: Alla rännor levereras endast med en (1) tätning.

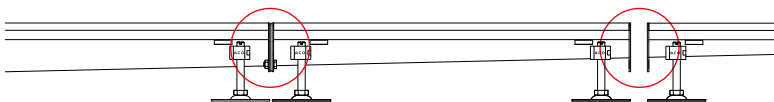

Vinkelränna

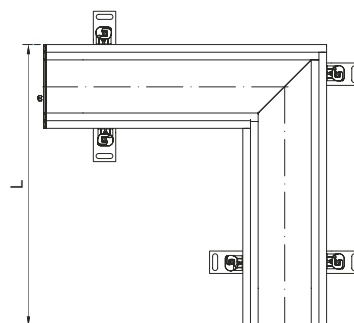
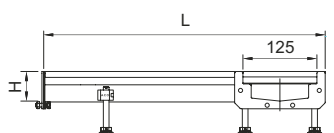
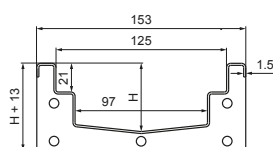
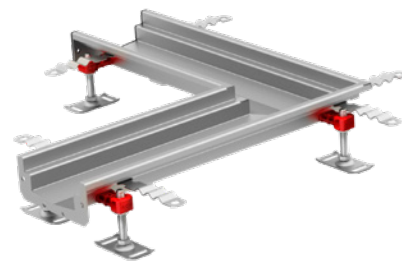

Dimension		Artikelnummer	
L	H	1.4301	1.4404
[mm]	[mm]		
515	50	409812	409818
	65	409813	409819
	80	409814	409820
	95	409815	409821
	110	409816	409822
	125	409817	409823

T-stycke

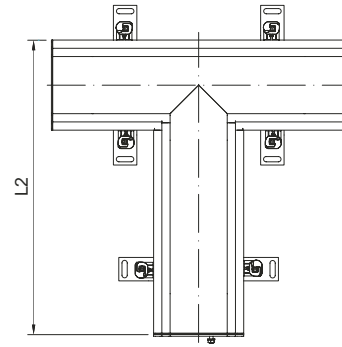
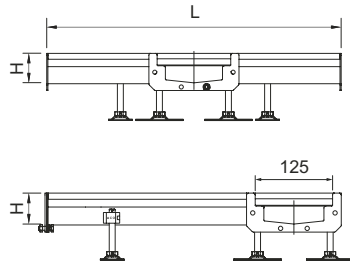
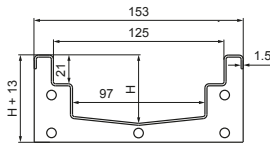
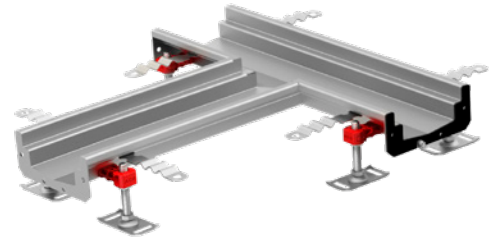

Dimension			Artikelnummer	
L1	L2	H	1.4301	1.4404
[mm]	[mm]	[mm]		
500	515	50	409824	409830
		65	409825	409831
		80	409826	409832
		95	409827	409833
		110	409828	409834
		125	409829	409835

Rännöverdel med ändplacerat utlopp

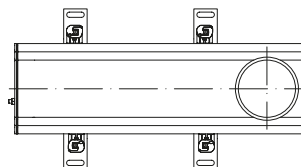
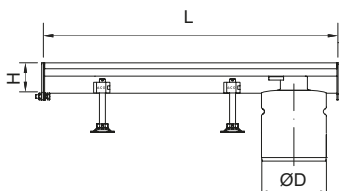
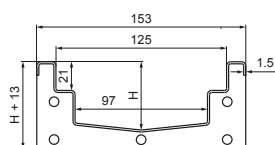

Dimension		Brunnstyp	Utloppsdiameter	Artikelnummer	
L	H		ØD	1.4301	1.4404
[mm]	[mm]		[mm]		
500	50	Endast bottenutlopp	110	105175	407251
	65			105176	407252
	80			105177	407253
	95			105178	407254
	110			105179	407255
	125			105180	407256
1000	50	Endast bottenutlopp	110	105183	407257
	65			105184	407258
	80			105185	407259
	95			105186	407260
	110			105187	407261
	125			105188	407262
500	50	ACO Brunn 142	125	415946	415991
	65			415947	415992
	80			415948	415993
	95			415949	415994
	110			415950	415995
	125			415951	415996
1000	50	ACO Brunn 142	125	415952	415997
	65			415953	415998
	80			415954	415999
	95			415955	416000
	110			415956	416001
	125			415957	416002
500	50	ACO Brunn 157	142	409732	409733
	65			409736	409737
	80			409740	409741
	95			409744	409745
	110			409724	409725
	125			409728	409729
1000	50	ACO Brunn 157	142	409708	409709
	65			409712	409713
	80			409716	409717
	95			409720	409721
	110			409700	409701
	125			409704	409705

Rännöverdel med mittplacerat utlopp

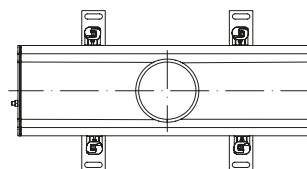
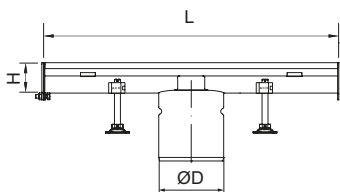
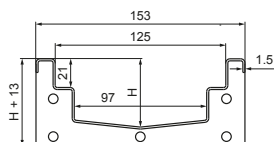
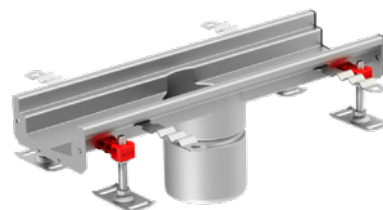

Dimension		Brunnstyp	Utloppsdiameter	Artikelnummer	
L	H		ØD	1.4301	1.4404
[mm]	[mm]		[mm]		
500	50	Endast bottenutlopp	110	105191	407263
	65			105192	407264
	80			105193	407265
	95			105194	407266
	110			105195	407267
	125			105196	407268
1000	50	Endast bottenutlopp	110	105199	407269
	65			105200	407270
	80			105201	407271
	95			105202	407272
	110			105203	407273
	125			105204	407274
500	50	ACO Brunn 142	125	415958	416003
	65			415959	416004
	80			415960	416005
	95			415961	416006
	110			415962	416007
	125			415963	416008
1000	50	ACO Brunn 142	125	415964	416009
	65			415965	416010
	80			415966	416011
	95			415967	416012
	110			415968	416013
	125			415969	416014
500	50	ACO Brunn 157	142	409734	409735
	65			409738	409739
	80			409742	409743
	95			409746	409747
	110			409726	409727
	125			409730	409731
1000	50	ACO Brunn 157	142	409710	409711
	65			409714	409715
	80			409718	409719
	95			409722	409723
	110			409702	409703
	125			409706	409707

Rännöverdel med ändplacerat brunnsutlopp

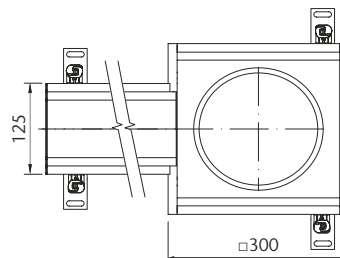
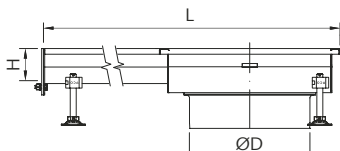
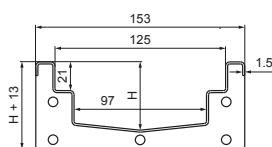
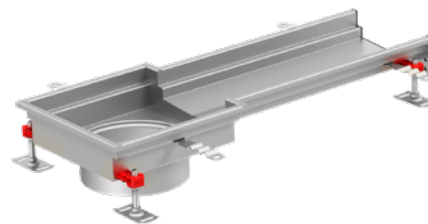

Dimension		Brunnstyp	Utloppsdiameter	Artikelnummer	
L [mm]	H [mm]		ØD [mm]	1.4301	1.4404
785	65	ACO Brunn 218	200	Z379177	Z379182
	80			Z379178	Z379183
	95			Z379170	Z379184
	110			Z379180	Z379185
	125			Z379181	Z379186

Rännöverdel med mittplacerat brunnsutlopp

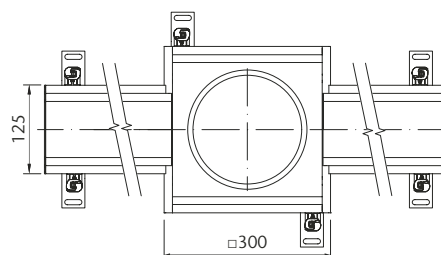
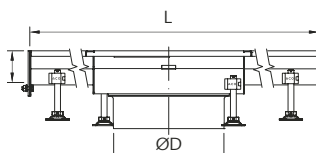
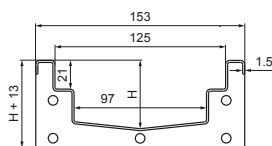
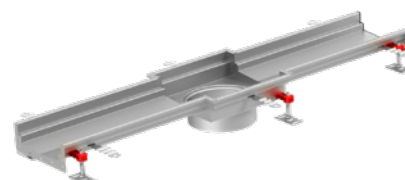

Dimension		Brunnstyp	Utloppsdiameter	Artikelnummer	
L [mm]	H [mm]		ØD [mm]	1.4301	1.4404
1270	65	ACO Brunn 218	200	Z379921	Z379926
	80			Z379922	Z379928
	95			Z379923	Z379929
	110			Z379924	Z379930
	125			Z379925	Z379931

Brunnsunderdelar

Brunnsunderdelar med bottenutlopp

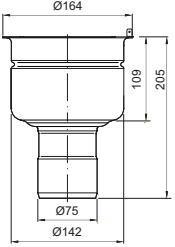
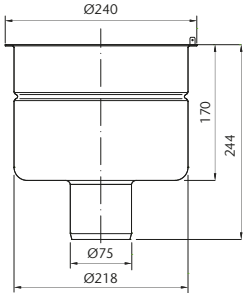
	Modell	Utlopps- riktning	Utlopps- diameter Ø [mm]	Vattenlås	Material	Artikelnr.
	ACO Brunn 142	Vertikal	75	Ja	1.4301	414709
					1.4404	414809
				Nej	1.4301	414708
					1.4404	414808
	ACO Brunn 157	Vertikal	75	Ja	1.4301	408049
					1.4404	408149
				Nej	1.4301	408048
					1.4404	408148
	ACO Brunn 218	Vertikal	75	Ja	1.4301	408046
					1.4404	408146
				Nej	1.4301	413203
					1.4404	413201

Brunnsunderdelar med bottenutlopp

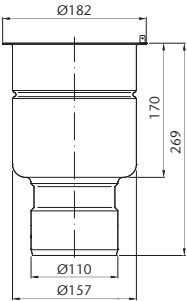
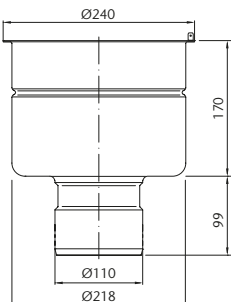
	Modell	Utlopps- riktning	Utlopps- diameter Ø [mm]	Vattenlås	Material	Artikelnr.
	ACO Brunn 157	Vertikal	110	Ja	1.4301	408055
					1.4404	408155
				Nej	1.4301	408054
					1.4404	408154
	ACO Brunn 218	Vertikal	110	Ja	1.4301	408061
					1.4404	408155
				Nej	1.4301	408060
					1.4404	408160

Brunnsunderdelar med sidoutlopp

	Modell	Utlopps- riktning	Utlopps- diameter Ø [mm]	Vattenlås	Material	Artikelnr.
	ACO Brunn 142	Horisontell	75	Ja	1.4301	414721
					1.4404	414821
				Nej	1.4301	414720
					1.4404	414820
	ACO Brunn 157	Horisontell	75	Ja	1.4301	408073
					1.4404	408173
				Nej	1.4301	408072
					1.4404	408172
	ACO Brunn 218	Horisontell	75	Ja	1.4301	408098
					1.4404	408198
				Nej	1.4301	413202
					1.4404	413200

Brunnsunderdelar med sidoutlopp

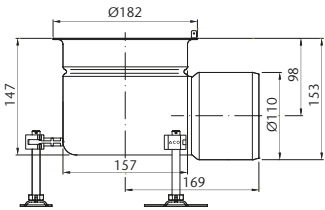
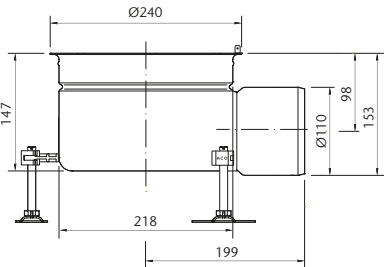
	Modell	Utlopps- riktning	Utlopps- diameter Ø [mm]	Vattenlås	Material	Artikelnr.
	ACO Brunn 157	Horisontell	110	Ja	1.4301	408079
					1.4404	408179
				Nej	1.4301	408078
					1.4404	408178
	ACO Brunn 218	Horisontell	110	Ja	1.4301	408085
					1.4404	408185
				Nej	1.4301	408084
					1.4404	408184

Galler för rännor

- Testad och godkänd enligt EN 1433
- Tillgänglig i rostfritt stål EN 1.4301 och rostfritt syrafast stål EN 1.4404
- Speciallängd 375 mm för T-stycken och vinkelrännor
- Halkskydd för ökad säkerhet
- Belastningsklass enligt EN 1433: A 15, B 125 och C 250
- Kan beställas i specialanpassad längd, se sid. 48
- Kan beställas med egen design, se sid. 49

ACO Steggaller utan ram

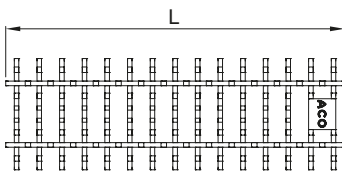

Längd L [mm]	Belastningsklass SS-EN 1433	Halkfritt	Material	Artikelnr.
375	C 250	Ja	1.4301	446280
			1.4404	446281
500	C 250	Ja	1.4301	446276
			1.4404	446277

ACO Steggaller

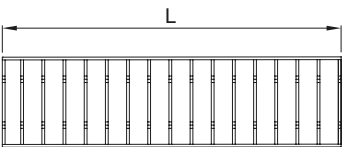

Längd L [mm]	Belastningsklass SS-EN 1433	Halkfritt	Material	Artikelnr.
375	C 250	Ja	1.4301	414134
			1.4404	414184
500	C 250	Ja	1.4301	21740
			1.4404	21745
1000	C 250	Ja	1.4301	21741
			1.4404	21746

ACO Rutgaller

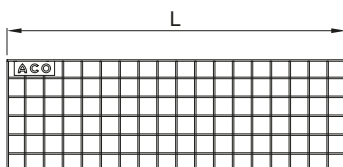

Längd L [mm]	Belastningsklass SS-EN 1433	Halkfritt	Material	Artikelnr.
375	A 15	Nej	1.4301	414132
			1.4404	414182
		Ja	1.4301	414130
	C 250	Nej	1.4404	414180
			1.4301	414133
		Ja	1.4404	414183
500	A 15	Nej	1.4301	414131
			1.4404	414181
		Ja	1.4301	21720
	C 250	Nej	1.4404	21725
			1.4301	21710
		Ja	1.4404	21715
1000	A 15	Nej	1.4301	21920
			1.4404	21925
		Ja	1.4301	21910
	C 250	Nej	1.4404	21915
			1.4301	21620
		Ja	1.4404	21625
C 250	Nej	1.4301	21610	
		1.4404	21615	
	Ja	1.4301	21820	
			1.4404	21825
			1.4301	21810
			1.4404	21815

ACO Heelsafe®-galler

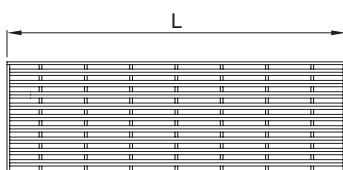

Längd L [mm]	Belastningsklass SS-EN 1433	Halkfritt	Material	Artikelnr.
375	B 125	Nej	1.4301	414135
			1.4404	414185
500	B 125	Nej	1.4301	96819
			1.4404	401238
1000	B 125	Nej	1.4301	96818
			1.4404	401237

ACO Perforerat galler

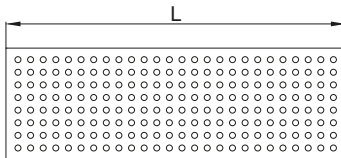

Längd L [mm]	Belastningsklass SS-EN 1433	Halkfritt	Material	Artikelnr.
375	A 15	Nej	1.4301	414136
			1.4404	414186
	B 125	Nej	1.4301	414137
			1.4404	414187
500	A 15	Nej	1.4301	21760
			1.4404	21765
	B 125	Nej	1.4301	21960
			1.4404	21965
1000	A 15	Nej	1.4301	21660
			1.4404	21665
	B 125	Nej	1.4301	21860
			1.4404	21865

ACO Quadrato-galler

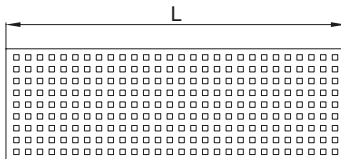

Längd L [mm]	Belastningsklass SS-EN 1433	Halkfritt	Låsbart	Material	Artikelnr.
375	A 15	Nej	Nej	1.4301	414138
				1.4404	414188
500	A 15	Nej	Nej	1.4301	105530
				1.4404	413999
			Ja	1.4301	105528
				1.4404	407925
1000	A 15	Nej	Nej	1.4301	105529
				1.4404	413998
			Ja	1.4301	105527
				1.4404	407924

ACO Multi-slot, 5 galler

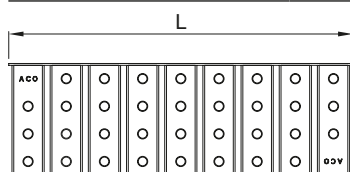

Längd L [mm]	Belastningsklass SS-EN 1433	Halkfritt	Material	Artikelnr.
375	A 15	Ja	1.4301	414139
			1.4404	414189
500	A 15	Ja	1.4301	409290
			1.4404	409291
	B 125	Ja	1.4301	409294
			1.4404	409295
1000	A 15	Ja	1.4301	409286
			1.4404	409287
	B 125	Ja	1.4301	409236
			1.4404	409237

ACO Multi-slot, 8 galler

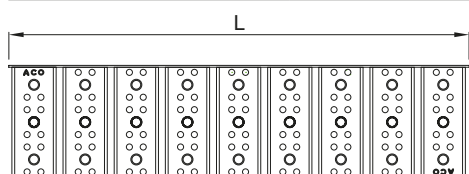

Längd L [mm]	Belastningsklass SS-EN 1433	Halkfritt	Material	Artikelnr.	
500	A 15	Ja	1.4301	415739	
			1.4404	415740	
	B 125	Ja	1.4301	415747	
			1.4404	415748	
		C 250	Ja	1.4301	415753
				1.4404	415754
1000	A 15	Ja	1.4301	415735	
			1.4404	415736	
	B 125	Ja	1.4301	415743	
			1.4404	415744	
		C 250	Ja	1.4301	415751
				1.4404	415752

ACO Tät slitsbetäckning

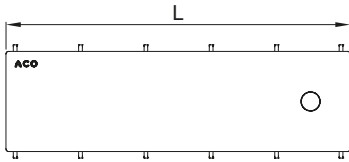

Längd L [mm]	Belastningsklass SS-EN 1433	Halkfritt	Material	Artikelnr.
375	B 125	Ja	1.4301	445800
			1.4404	445801
	C 250	Ja	1.4301	445802
			1.4404	445803
500	A 15	Ja	1.4301	445792
			1.4404	445793
	B 125	Ja	1.4301	445794
			1.4404	445795
1000	A 15	Ja	1.4301	445796
			1.4404	445797
	B 125	Ja	1.4301	445798
			1.4404	445799

ACO Plastgaller

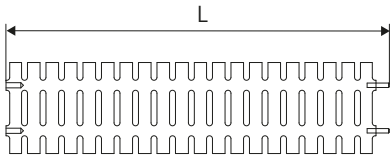

Längd L [mm]	Belastningsklass SS-EN 1433	Halkfritt	Material	Artikelnr.
500	A 15	Nej	Vit polyeten	21790
1000	A 15	Nej	Vit polyeten	21690

22

ACO Plastgaller

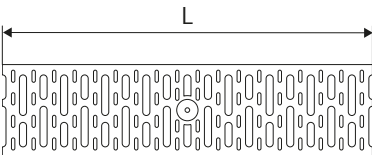

Längd L [mm]	Belastningsklass SS-EN 1433	Halkfritt	Låsbart	Material	Artikelnr.
500	C 250	Nej	Ja	Svart plast	15704

Galler 300 x 300 mm till brunnsöverdelar

- Testad och godkänd enligt EN 1253
- Tillgänglig i rostfritt stål 1.4301 och rostfritt syrafäst stål 1.4404
- Speciallängd 300 mm för T-stycken och vinkelrännor
- Halkskydd finns på flera modeller för ökad säkerhet
- Belastningsklass L 15, R 50, M 125 och N 250

ACO Steggaller utan ram

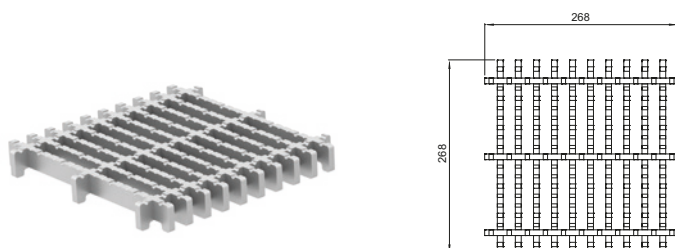

Belastningsklass	Halkskydd	Material	Artikelnr.
M 125	Ja	1.4301	446272
		1.4404	446273

ACO Steggaller

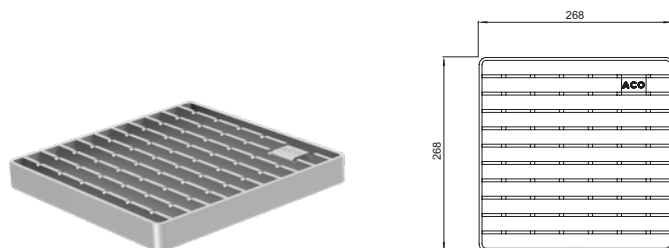

Belastningsklass	Halkskydd	Material	Artikelnr.
R 50	Ja	1.4301	416916
		1.4404	416917
M 125	Ja	1.4301	408037
		1.4404	408137
N 250	Nej	1.4301	408045
		1.4404	408145

23

ACO Rutgaller

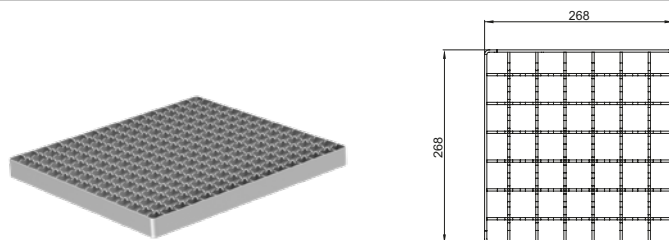

Belastningsklass	Halkskydd	Material	Artikelnr.
L 15	Ja	1.4301	408034
		1.4404	408134
	Nej	1.4301	408035
		1.4404	408135

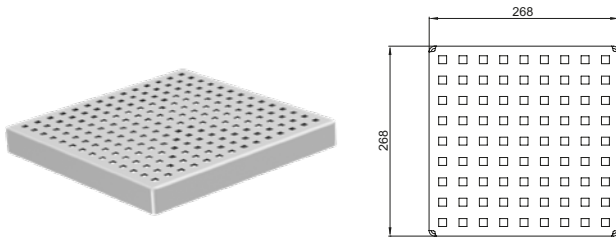
ACO Quadrato

Belastningsklass	Halkskydd	Material	Artikelnr.
L 15	Nej	1.4301	408036
		1.4404	408136

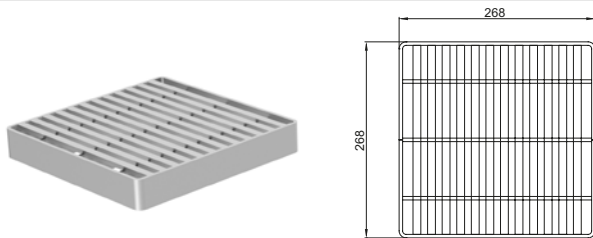
ACO Heelsafe®

Belastningsklass	Halkskydd	Material	Artikelnr.
L 15	Nej	1.4301	408040
		1.4404	408140

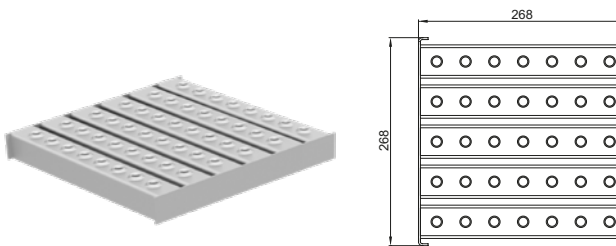
ACO Multi-slot

Belastningsklass	Halkskydd	Material	Artikelnr.
L 15	Ja	1.4301	408042
		1.4404	408142

24

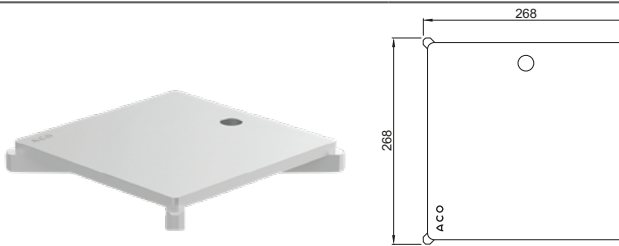
ACO Tät slitsbetäckning

Belastningsklass	Halkskydd	Material	Artikelnr.
R 50	Ja	1.4301	445788
		1.4404	445789
M 125	Ja	1.4301	445790
		1.4404	445791

Tillval för Modular M125

Tät gavel

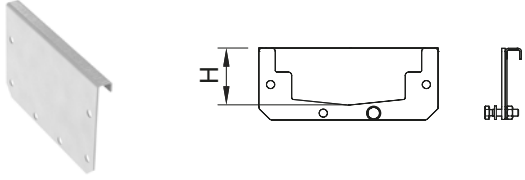
	Dimension		Artikelnummer	
	H [mm]	1.4301	1.4404	
	50	105100	407196	
	65	105101	407197	
	80	105102	407198	
	95	105103	407199	
	110	105104	407200	
	125	105105	407201	

Utloppsgavel

■ DN50

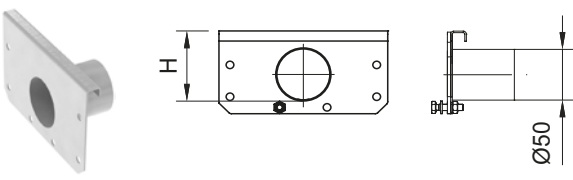
	Dimension		Artikelnummer	
	H [mm]	1.4301	1.4404	
	65	409114	409119	
	80	409115	409120	
	95	409116	409121	
	110	409117	409122	
	125	409118	409123	

NBR-tätning

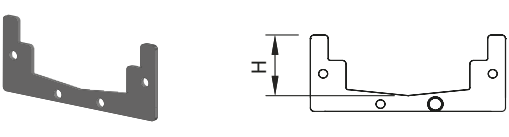
	Dimension		Artikelnummer	
	H [mm]			
	50		413587	
	65		413588	
	80		413589	
	95		413590	
	110		413591	
	125		413592	

Ingjutningsskydd

- Skyddar rännan mot deformation vid gjutning
- Förhindrar att byggavfall kommer ner i brunnen eller rännan i byggfasen
- Underlättar rengöring efter installation
- Förhindrar personskador på byggarbetsplatsen
- Certifierad enligt EN 12811-1 med belastningsklass 3

	Dimension		Artikelnummer	
	[mm]			
	För rännöverdel	121 x 996 x 20	OSB001237	
	För rännöverdel med utloppsdel B110	121 x 996 x 20	OSB001238	
	För rännöverdel	121 x 496 x 20	OSB001239	

Adapter ränna/sandfång

	Invändig höjd ränna		Artikelnummer	
	H [mm]		1.4301	1.4404
	50/95		Z418650	Z418642
	65/95		Z418649	Z418641
	80/95		Z418648	Z418640





Sandfång

	Dimension		Artikelnummer	
	Längd [mm]	Djup [mm]	1.4301	1.4404
	500	350	Z403401	Z403397
		500	Z403400	Z403363

Slamspann för sandfång

	Dimension			Artikelnummer	
	Längd [mm]	Bredd [mm]	Djup [mm]	1.4301	1.4404
	452	93	100	Z403411	Z403404
			250	Z403410	Z403403

	Beskrivning	Passar till	Material	Artikelnr.
	ACO Vattenlås ■ Rostfritt stål	ACO Modular M125 med utlopp Ø110 mm	1.4301	97217
			1.4404	97267
	ACO Vattenlås med silkorg ■ Rostfritt syrafast stål ■ Höjd: 50 mm	ACO Modular M125 med utlopp Ø110 mm	1.4301	414339
			1.4404	414340
	ACO Vattenlås Easy Fat ■ Rostfritt stål	ACO Modular M125 med brunnsutlopp Ø125 mm	1.4301	449677
			1.4404	449679
		ACO Modular M125 med brunnsutlopp Ø142 mm	1.4301	448810
			1.4404	448811
		ACO Modular M125 med brunnsutlopp Ø200 mm	1.4301	449685
			1.4404	449687
	ACO Vattenlås Easy Fat med silkorg ■ Rostfritt stål	ACO Modular M125 med brunnsutlopp Ø125 mm	1.4301	449678
			1.4404	449680
		ACO Modular M125 med brunnsutlopp Ø142 mm	1.4301	449096
			1.4404	449128
		ACO Modular M125 med brunnsutlopp Ø200 mm	1.4301	449686
			1.4404	449688
	ACO Siltallrik ■ Rostfritt stål	ACO Modular M125 med utlopp Ø110 mm	1.4301	97235
			1.4404	97285
	ACO Silkorg ■ Rostfritt stål ■ Volym: 0,5 liter	ACO Modular M125 med utlopp Ø125 och Ø142 mm	1.4301	414339
			1.4404	414340
	ACO Sandfång 218 ■ För spygattutförande med brunnsutlopp Ø200 mm ■ Rostfritt stål ■ Ø211 x 145 mm ■ Volym: 3 liter	ACO Modular M125 med brunnsutlopp Ø200 mm	1.4301	Z424682
			1.4404	Z424683

	Beskrivning	Passar till	Material	Artikelnr.
	ACO Radontätning ■ Rostfritt stål	Ø75 mm	SBR/EPDM	3330075
		Ø110 mm	SBR/EPDM	3330110
		Ø157 mm	SBR/EPDM	3330160
		Ø218 mm	SBR/EPDM	3330218
	ACO Ställfot ■ Galvaniserat stål	■ ACO brunnsunderdelar <input type="checkbox"/> Fast <input type="checkbox"/> Teleskopisk	50 mm	NM8349
			110 mm	NM9815
			185 mm	NM9232
			255 mm	NM5975
	ACO Snabbfäste ■ För enkel nivåreglering vid ingjutning	■ ACO Ställfot	300 mm	NM6565
				NM9486
	ACO Lyftkrok 600 x 104 x 5 mm ■ Rostfritt stål	■ ACO Galler	1.4301	Z221923

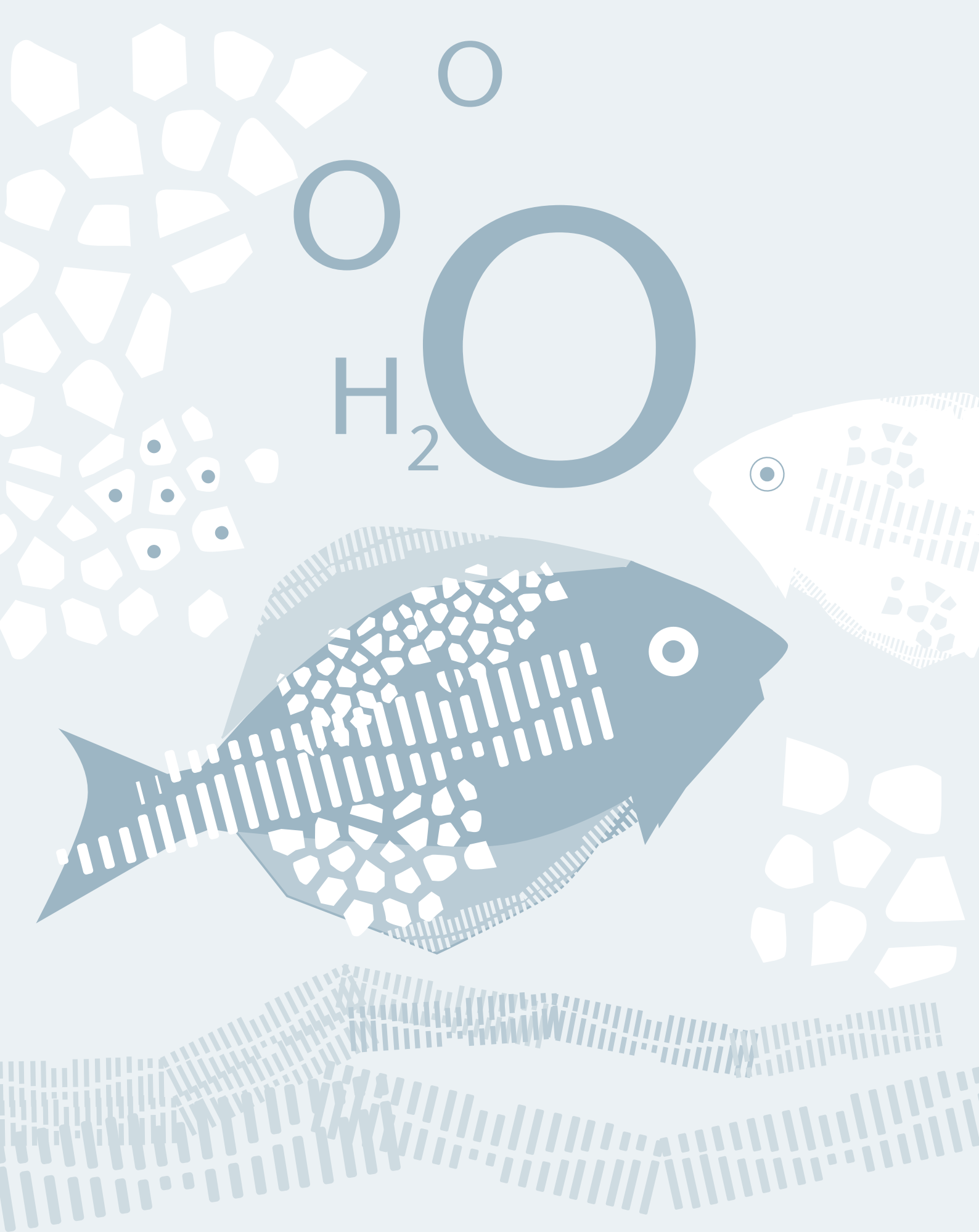

ACO. we care for water

ACO Modular M200

ACO Modul-serien är rostfria rännor som är avsedda för kommersiella och industriella applikationer med fokus på livslängd och funktion.

V-formad rännbotten medför ökad flödes hastighet vid låga flöden och bättre självreningseffekt.

- Kompatibel med EN 125
- Testad och godkänd enligt EN 1433
- Tillgängligt i rostfritt stål 1.4301 och rostfritt syrafast stål 1.4404
- Betad
- Teleskopisk lösning med brunn
- Brett gällersortiment upp till C 250 (EN 1433)
- Kan beställas i specialanpassad längd, se sid. 48
- Kan beställas med egendesignade galler, se sid. 49

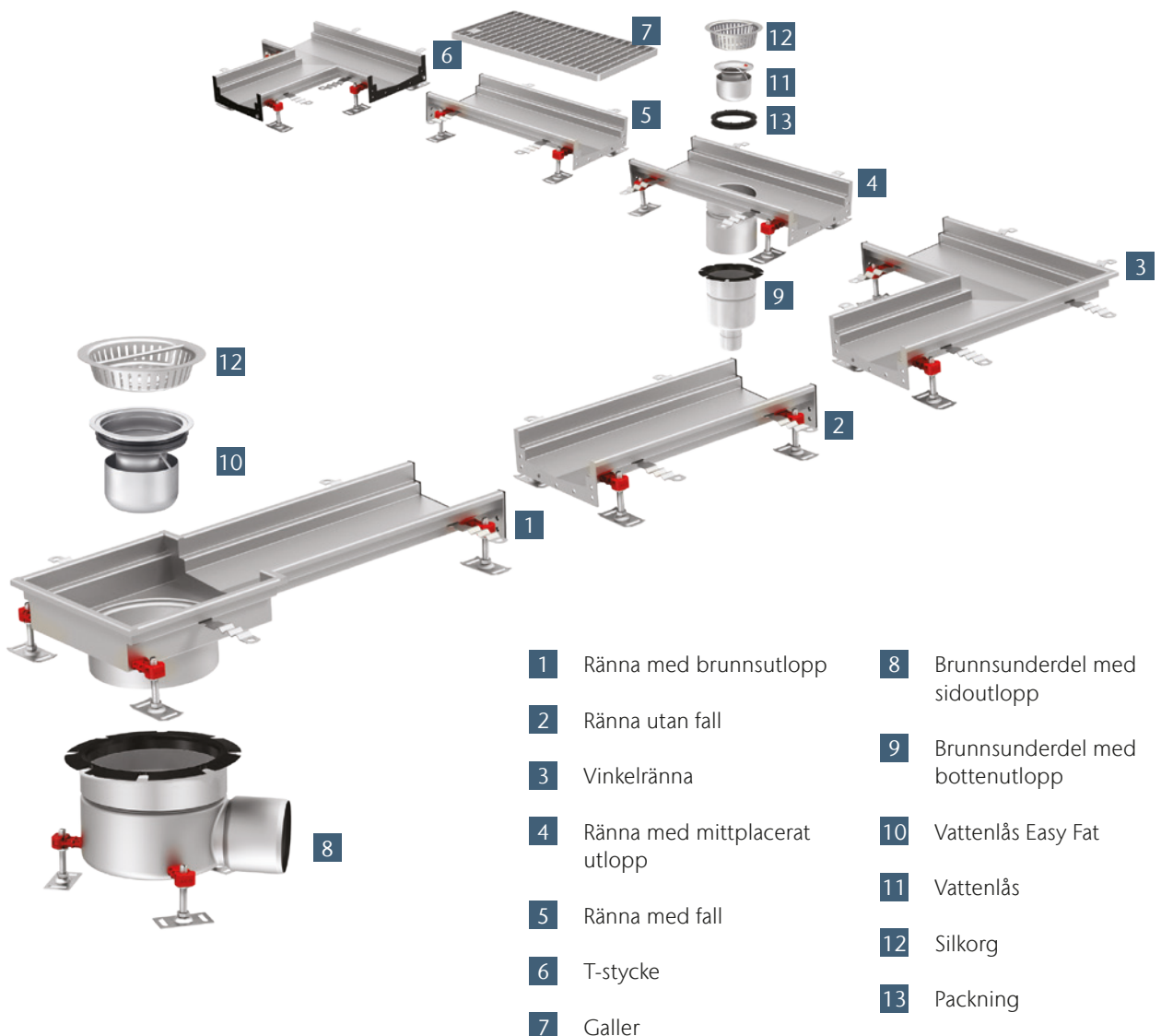

Rännor

Ränna utan fall

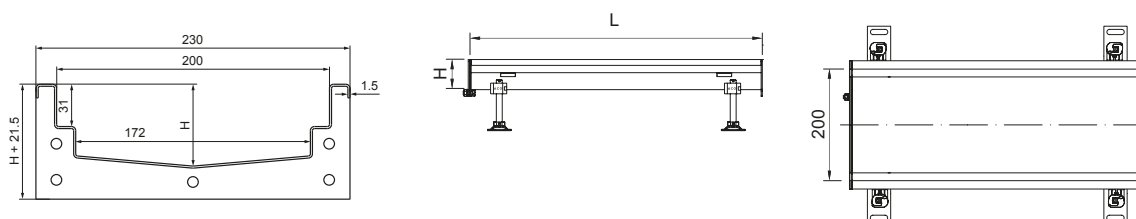
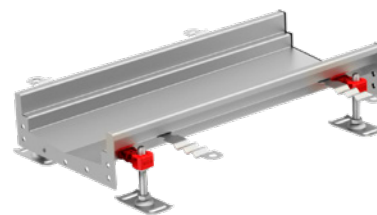

Dimension		Artikelnr.	
L	H	1.4301	1.4404
[mm]	[mm]		
500	60	409072	409050
	70	409047	409051
	80	409048	409052
	100	409049	409053
1000	60	401859	401860
	70	409054	409057
	80	409055	409058
	100	409056	409059
2000	60	401875	401876
	70	409060	409063
	80	409061	409064
3000	100	409062	409065
	60	401895	401896
	70	409066	409069
	80	409067	409070
	100	409068	409071

Ränna med fall

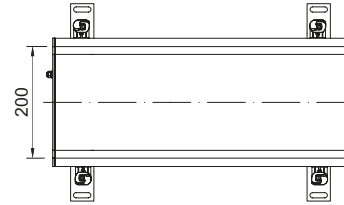
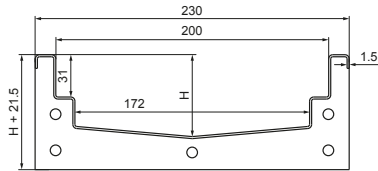
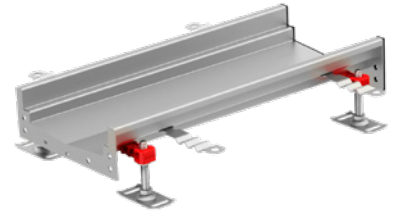

L	Dimension		Artikelnr.		
	[mm]	H1 [mm]	H2 [mm]	1.4301	1.4404
500		55	60	401855	401856
		60	70	401871	401872
		70	80	402464	402465
1000		80	90	402466	402467
		90	100	402468	402469
		100	110	402470	402471
		60	70	401887	401888
2000		70	80	402472	402473
		80	90	402474	402475
		90	100	402476	402477
		100	110	402478	402479
		110	120	402480	402481
		60	80	402482	402483
3000		80	100	402484	402485
		100	120	402486	402487
		120	140	402488	402489
6000		60	100	408827	408829
		100	140	408828	408830

32



Info: Alla rännor levereras endast med en (1) tätning.

Vinkelränna

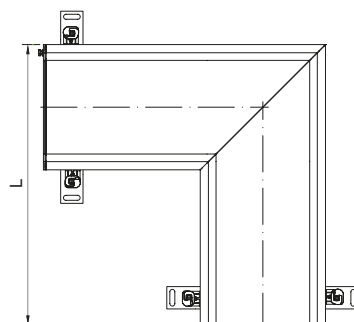
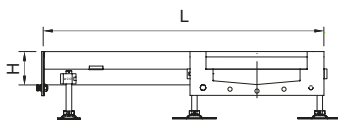
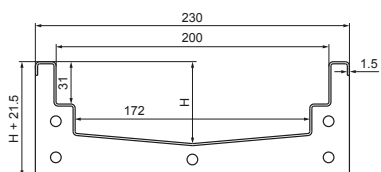
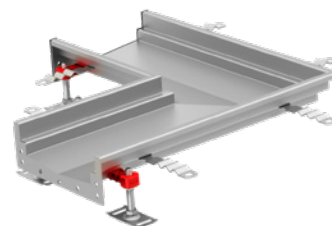

Dimension		Artikelnummer	
L	H	1.4301	1.4404
[mm]	[mm]		
515	60	401921	401922
	80	402490	402491
	100	402492	402493

T-stycke

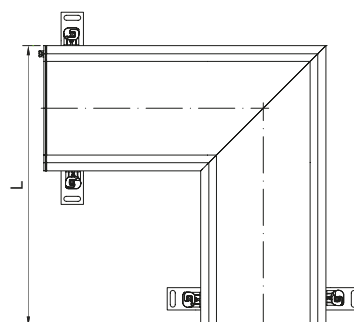
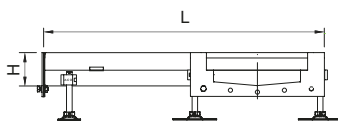
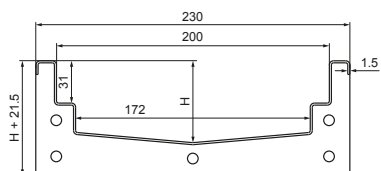
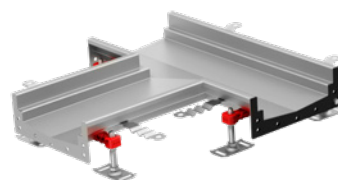

Dimension			Artikelnummer	
L1	L2	H	1.4301	1.4404
[mm]	[mm]	[mm]		
500	515	60	401933	401934
		80	402494	402495
		100	402496	402497

Ränna med ändplacerat utlopp

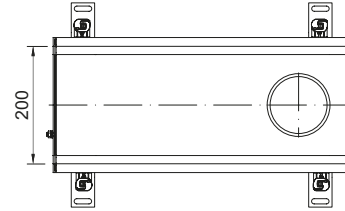
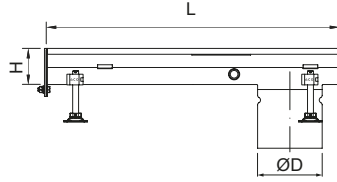
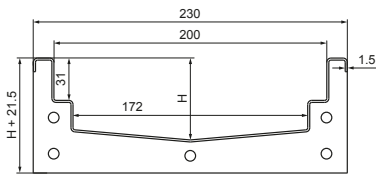
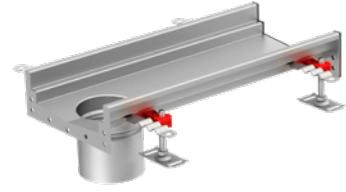

Dimension		Brunnstyp	Utloppsdiameter	Artikelnummer	
L	H		ØD	1.4301	1.4404
[mm]	[mm]		[mm]		
500	60	Endast bottenutlopp	110	414275	414283
	70			414276	414284
	80			414277	414285
	90			414278	414286
	100			414279	414287
	110			414280	414288
	120			414281	414289
	140			414282	414290
1000	60	Endast bottenutlopp	110	414291	414299
	70			414292	414300
	80			414293	414301
	90			414294	414302
	100			414295	414303
	110			414296	414304
	120			414297	414305
	140			414298	414306
500	60	ACO Brunn 157	142	409900	409908
	70			409901	409909
	80			409902	409910
	90			409903	409911
	100			409904	409912
	110			409905	409913
	120			409906	409914
	140			409907	409915
1000	60	ACO Brunn 157	142	409932	409940
	70			409933	409941
	80			409934	409942
	90			409935	409943
	100			409936	409944
	110			409937	409945
	120			409938	409946
	140			409939	409947

Ränna med mittplacerat utlopp

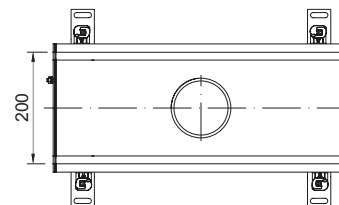
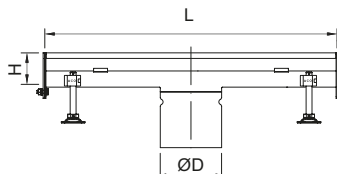
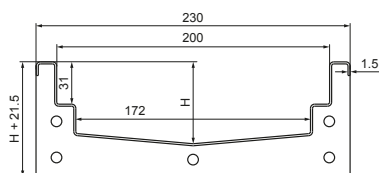

Dimension		Brunnstyp	Utloppsdiameter	Artikelnummer	
L	H		ØD	1.4301	1.4404
[mm]	[mm]		[mm]		
500	60	Endast bottenutlopp	110	414307	414315
	70			414308	414316
	80			414309	414317
	90			414310	414318
	100			414311	414319
	110			414312	414320
	120			414313	414321
	140			414314	414322
1000	60	Endast bottenutlopp	110	414323	414331
	70			414324	414332
	80			414325	414333
	90			414326	414334
	100			414327	414335
	110			414328	414336
	120			414329	414337
	140			414330	414338
500	60	ACO Brunn 157	142	409916	409924
	70			409917	409925
	80			409918	409926
	90			409919	409927
	100			409920	409928
	110			409921	409929
	120			409922	409930
	140			409923	409931
1000	60	ACO Brunn 157	142	409948	409956
	70			409949	409957
	80			409950	409958
	90			409951	409959
	100			409952	409960
	110			409953	409961
	120			409954	409962
	140			409955	409963

Ränna med ändplacerat brunnsutlopp

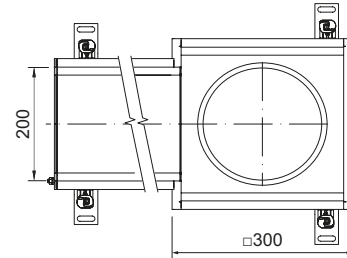
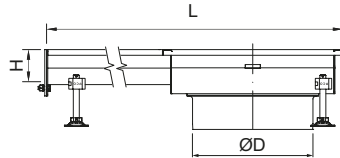
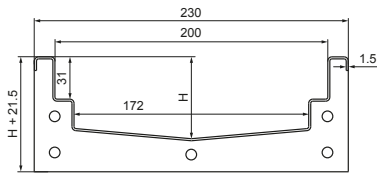
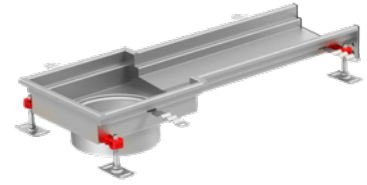

Dimension		Brunnstyp	Utloppsdiаметer ØD [mm]	Artikelnummer	
L [mm]	H [mm]			1.4301	1.4404
785	60	ACO Brunn 218	200	414259	414267
	70			414260	414268
	80			414261	414269
	90			414262	414270
	100			414263	414271
	110			414264	414272
	120			414265	414273
	140			414266	414274

Ränna med mittplacerat brunnsutlopp

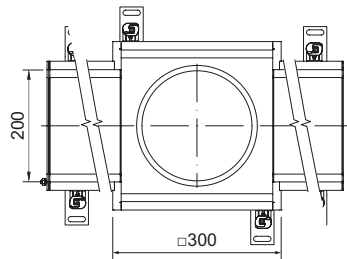
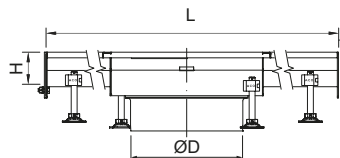
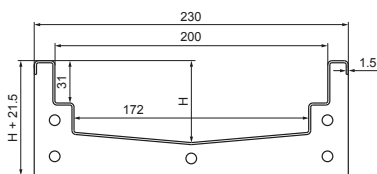
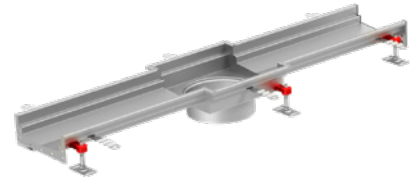

Dimension		Brunnstyp	Utloppsdiаметer ØD [mm]	Artikelnummer	
L [mm]	H [mm]			1.4301	1.4404
1270	60	ACO Brunn 218	200	414243	414251
	70			414244	414252
	80			414245	414253
	90			414246	414254
	100			414247	414255
	110			414248	414256
	120			414249	414257
	140			414250	414258

Brunnsunderdelar

Brunnsunderdelar med bottenutlopp

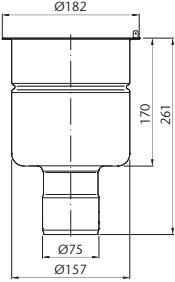
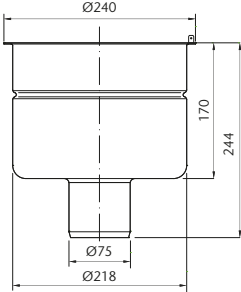
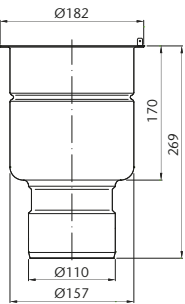
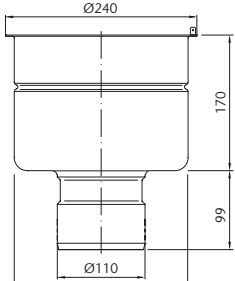
	Modell	Utlopps- riktning	Utlopps- diameter Ø [mm]	Vattenlås	Material	Artikelnr.
	ACO Brunn 157	Vertikal	75	Ja	1.4301	408049
					1.4404	408149
				Nej	1.4301	408048
					1.4404	408148
	ACO Brunn 218	Vertikal	75	Ja	1.4301	408064
					1.4404	408164
				Nej	1.4301	413203
					1.4404	413201
	ACO Brunn 157	Vertikal	110	Ja	1.4301	408055
					1.4404	408155
				Nej	1.4301	408054
					1.4404	408154
	ACO Brunn 218	Vertikal	110	Ja	1.4301	408061
					1.4404	408161
				Nej	1.4301	408060
					1.4404	408160

Brunnsunderdelar med sidoutlopp

	Modell	Utlopps- riktning	Utlopps- diameter Ø [mm]	Vattenlås	Material	Artikelnr.
	ACO Brunn 157	Horisontell	75	Ja	1.4301	408073
					1.4404	408173
				Nej	1.4301	408072
					1.4404	408172
	ACO Brunn 218	Horisontell	75	Ja	1.4301	408098
					1.4404	408198
				Nej	1.4301	413202
					1.4404	413200
	ACO Brunn 157	Horisontell	110	Ja	1.4301	408079
					1.4404	408179
				Nej	1.4301	408078
					1.4404	408178
	ACO Brunn 218	Horisontell	110	Ja	1.4301	408085
					1.4404	408185
				Nej	1.4301	408084
					1.4404	408184

Galler till rännor

- Testad och godkänd enligt EN 1433
- Tillgänglig i rostfritt stål 1.4301 och rostfritt syrafast stål 1.4404
- Speciallängd 300 mm för T-stycken och vinkelrännor
- Halkskydd för ökad säkerhet
- Belastningsklass A 15, B 125 och C 250
- Kan beställas i specialanpassad längd, se sid. 48
- Kan beställas med egen design, se sid. 49

ACO Steggaller utan ram

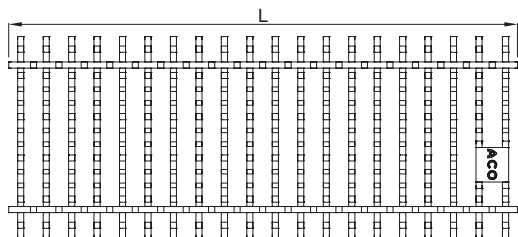

Längd L [mm]	Belastningsklass SS-EN 1433	Halkskydd	Material	Artikelnr.
300	C 250	Ja	1.4301	446288
			1.4404	446289
500	C 250	Ja	1.4301	446284
			1.4404	446285

ACO Steggaller

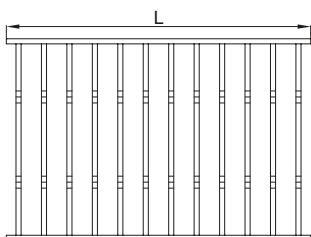

Längd L [mm]	Belastningsklass SS-EN 1433	Halkskydd	Material	Artikelnr.
300	C 250	Ja	1.4301	414142
			1.4404	414192
500	C 250	Ja	1.4301	92214
			1.4404	92264
1000	C 250	Ja	1.4301	92215
			1.4404	92265

ACO Rutgaller

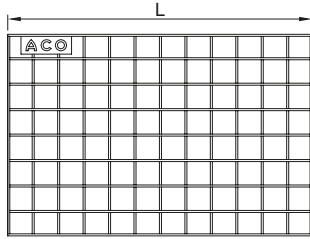

Längd L [mm]	Belastningsklass SS-EN 1433	Halkskydd	Material	Artikelnr.
300	A 15	Nej	1.4301	414141
			1.4404	414191
		Ja	1.4301	414140
			1.4404	414190
500	A 15	Nej	1.4301	92207
			1.4404	92257
		Ja	1.4301	92200
			1.4404	92250
1000	A 15	Nej	1.4301	92208
			1.4404	92258
		Ja	1.4301	92201
			1.4404	92251

ACO Multi-slot, 5 galler

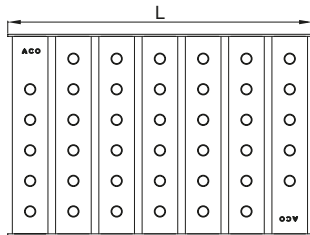

Längd L [mm]	Belastningsklass SS-EN 1433	Halkskydd	Material	Artikelnr.
300	A 15	Ja	1.4301	414145
			1.4404	414195
500	A 15	Ja	1.4301	409292
			1.4404	409293
	B 125	Ja	1.4301	409296
			1.4404	409297
1000	A 15	Ja	1.4301	409288
			1.4404	409289
	B 125	Ja	1.4301	409240
			1.4404	409241

ACO Multi-slot, 8 galler

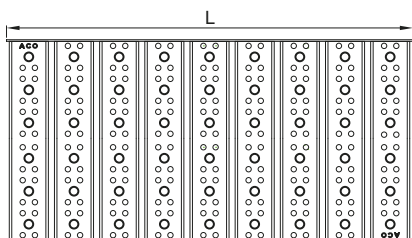

Längd L [mm]	Belastningsklass SS-EN 1433	Halkskydd	Material	Artikelnr.
500	A 15	Ja	1.4301	415741
			1.4404	415742
	B 125	Ja	1.4301	415749
			1.4404	415750
1000	A 15	Ja	1.4301	415737
			1.4404	415738
	B 125	Ja	1.4301	415745
			1.4404	415746

ACO Perforerat galler

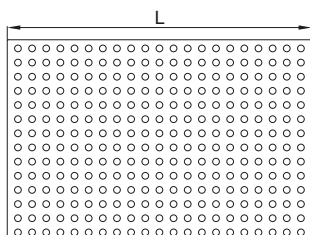

Längd L [mm]	Belastningsklass SS-EN 1433	Halkskydd	Material	Artikelnr.
300	A 15	Nej	1.4301	414143
			1.4404	414193
500	A 15	Nej	1.4301	402689
			1.4404	405188
1000	A 15	Nej	1.4301	402688
			1.4404	405187

ACO Tät slitsbetäckning

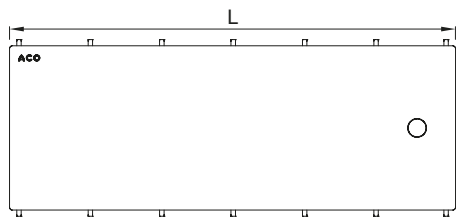

Längd L [mm]	Belastningsklass SS-EN 1433	Halkskydd	Material	Artikelnr.
375	B 125	Ja	1.4301	445812
			1.4404	445813
	C 250	Ja	1.4301	445814
			1.4404	445815
500	B 125	Ja	1.4301	445804
			1.4404	445805
	C 250	Ja	1.4301	445806
			1.4404	445807
1000	B 125	Ja	1.4301	445808
			1.4404	445809
	C 250	Ja	1.4301	445810
			1.4404	445811

Galler 300 x 300 mm till brunnsöverdelar

- Testad och godkänd enligt EN 1253
- Tillgänglig i rostfritt stål 1.4301 och rostfritt syrafäst stål 1.4404
- Speciallängd 300 mm för T-stycken och vinkelrännor
- Halkskydd finns på flera modeller för ökad säkerhet
- Belastningsklass L 15, R 50, M 125 och N 250

ACO Steggaller utan ram

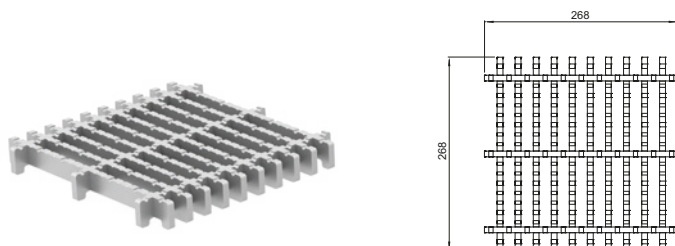

Belastningsklass	Halkskydd	Material	Artikelnr.
M 125	Ja	1.4301	446272
		1.4404	446273

ACO Steggaller

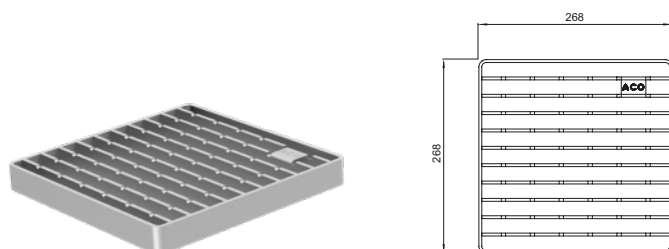

Belastningsklass	Halkskydd	Material	Artikelnr.
R 50	Ja	1.4301	416916
		1.4404	416917
M 125	Ja	1.4301	408037
		1.4404	408137
N 250	Nej	1.4301	408045
		1.4404	408145

ACO Rutgaller

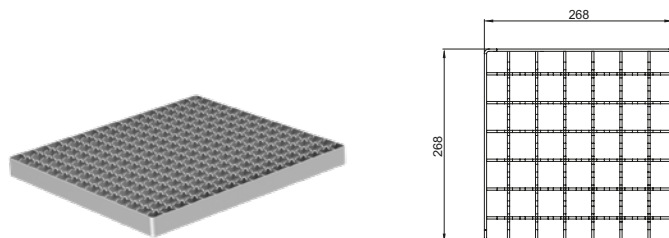

Belastningsklass	Halkskydd	Material	Artikelnr.
L 15	Ja	1.4301	408034
		1.4404	408134
	Nej	1.4301	408035
		1.4404	408135

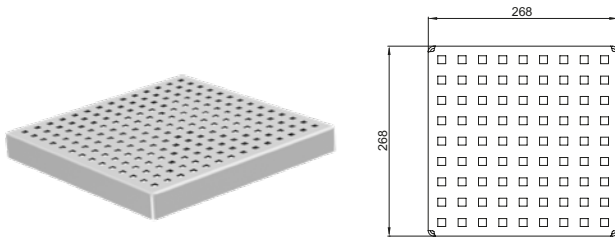
ACO Quadrato

Belastningsklass	Halkskydd	Material	Artikelnr.
L 15	Nej	1.4301	408036
		1.4404	408136

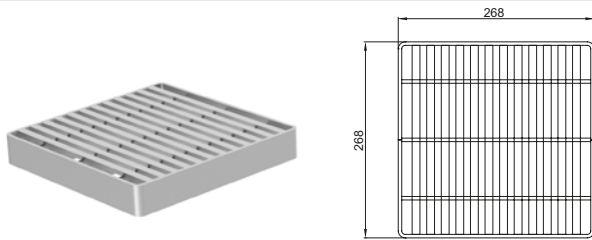
ACO Heelsafe®

Belastningsklass	Halkskydd	Material	Artikelnr.
L 15	Nej	1.4301	408040
		1.4404	408140

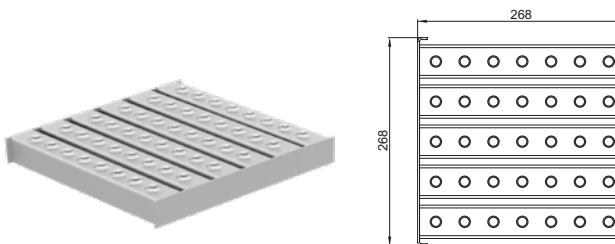
ACO Multi-slot

Belastningsklass	Halkskydd	Material	Artikelnr.
L 15	Ja	1.4301	408042
		1.4404	408142

44

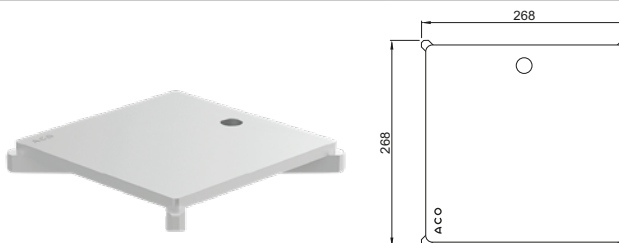
ACO Tät slitsbetäckning

Belastningsklass	Halkskydd	Material	Artikelnr.
R 50	Ja	1.4301	445788
		1.4404	445789
M 125	Ja	1.4301	445790
		1.4404	445791

Tillval till Modular M200

Tät gavel

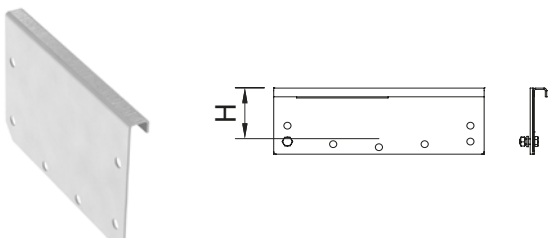
	Dimension		Artikelnummer	
	H [mm]	1.4301	1.4404	
	55	402683	402684	
	60	402028	402029	
	70	402030	402031	
	80	402514	402515	
	90	402032	402033	
	100	402516	402517	
	110	402518	402519	
	120	402036	402037	
	140	402520	402521	



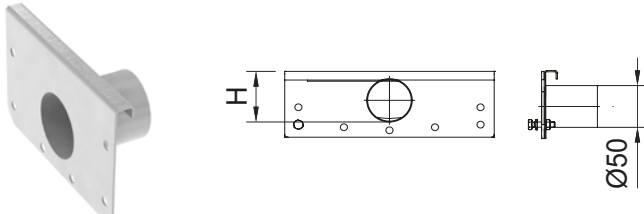

Gavelutlopp med 50 mm utlopp

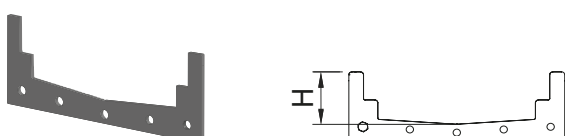
	Dimension		Artikelnummer	
	H [mm]	1.4301	1.4404	
	55	402001	402002	
	60	402003	402004	
	70	402005	402006	
	80	402034	402035	
	90	402007	402008	
	100	402024	402025	
	110	402020	402021	
	120	402022	402023	
	140	401999	402000	

NBR-tätning

	Dimension		Artikelnummer	
	H [mm]	1.4301	1.4404	
	60	413593	413594	
	70	413594	413595	
	80	413595	413596	
	90	413596	413597	
	100	413597	413598	
	110	413598	413599	
	120	413599	413600	
	140	413600		

	Beskrivning	Passar till	Material	Artikelnr.
	ACO Vattenlås ■ Rostfritt stål	ACO Modular M125 med utlopp Ø110 mm	1.4301	97217
			1.4404	97267
	ACO Vattenlås med silkorg ■ Rostfritt syrafast stål ■ Höjd: 50 mm	ACO Modular M125 med utlopp Ø110 mm	1.4301	414339
			1.4404	414340
	ACO Vattenlås Easy Fat ■ Rostfritt stål	ACO Modular M125 med brunnsutlopp Ø125 mm	1.4301	449677
		ACO Modular M125 med brunnsutlopp Ø142 mm	1.4404	449679
		ACO Modular M125 med brunnsutlopp Ø142 mm	1.4301	448810
		ACO Modular M125 med brunnsutlopp Ø200 mm	1.4404	448811
	ACO Vattenlås Easy Fat med silkorg ■ Rostfritt stål	ACO Modular M125 med brunnsutlopp Ø125 mm	1.4301	449678
		ACO Modular M125 med brunnsutlopp Ø142 mm	1.4404	449680
		ACO Modular M125 med brunnsutlopp Ø142 mm	1.4301	449096
		ACO Modular M125 med brunnsutlopp Ø142 mm	1.4404	449128
		ACO Modular M125 med brunnsutlopp Ø200 mm	1.4301	449686
		ACO Modular M125 med brunnsutlopp Ø200 mm	1.4404	449688
	ACO Siltallrik ■ Rostfritt stål	ACO Modular M125 med utlopp Ø110 mm	1.4301	97235
			1.4404	97285
	ACO Silkorg ■ Rostfritt stål ■ Volym: 0,5 liter	ACO Modular M125 med utlopp Ø125 och 142 mm	1.4301	414339
			1.4404	414340
	ACO Sandfång 218 ■ För spygattutförande med brunnsutlopp Ø200 mm ■ Rostfritt stål ■ Ø211 x 145 mm ■ Volym: 3 liter	ACO Modular M125 med brunnsutlopp Ø200 mm	1.4301	Z424682
			1.4404	Z424683

	Beskrivning	Passar till	Material	Artikelnr.
	ACO Radontätning ■ Rostfritt stål	Ø75 mm	SBR/EPDM	3330075
		Ø110 mm	SBR/EPDM	3330110
		Ø157 mm	SBR/EPDM	3330160
		Ø218 mm	SBR/EPDM	3330218
	ACO Ställfot ■ Galvaniserat stål	■ ACO brunnsunderdelar <input type="checkbox"/> Fast <input type="checkbox"/> Teleskopisk	50 mm	NM8349
			110 mm	NM9815
			185 mm	NM9232
			255 mm	NM5975
			300 mm	NM6565
	ACO Snabbfäste ■ För enkel nivåreglering vid ingjutning	■ ACO Ställfot		NM9486
	ACO Lyftkrok 600 x 104 x 5 mm ■ Rostfritt stål	■ ACO Galler	1.4301	Z221923

Specialanpassad ränna

ACO har även möjlighet att anpassa modurrännorna till en speciell längd. Rännorna levereras som ett komplett rännsystem direkt från fabrik som bara är att installera. Enkelt och smidigt.

Hur går det till?

Specialanpassade rännor är tillverkade av en ränna ur vårt standardsortiment som kapas enligt önskemål. Den kapade rännan levereras komplett med fläns och tätning för att passa nästföljande ränna. Valt galler kapas givetvis också enligt önskad längd.

Hur beställer man en specialanpassad modurränna?

Kontakta oss på ACO så hjälper vi till.

Telefon: 031-338 97 00
info@aco-nordic.se

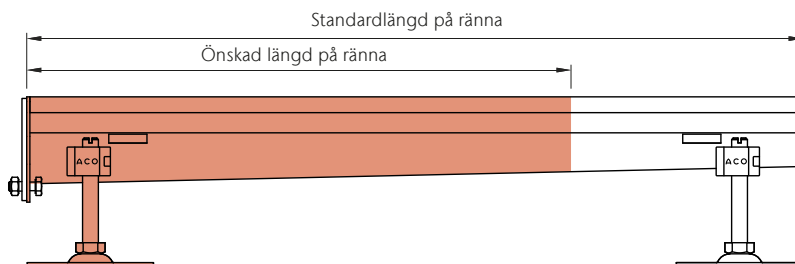
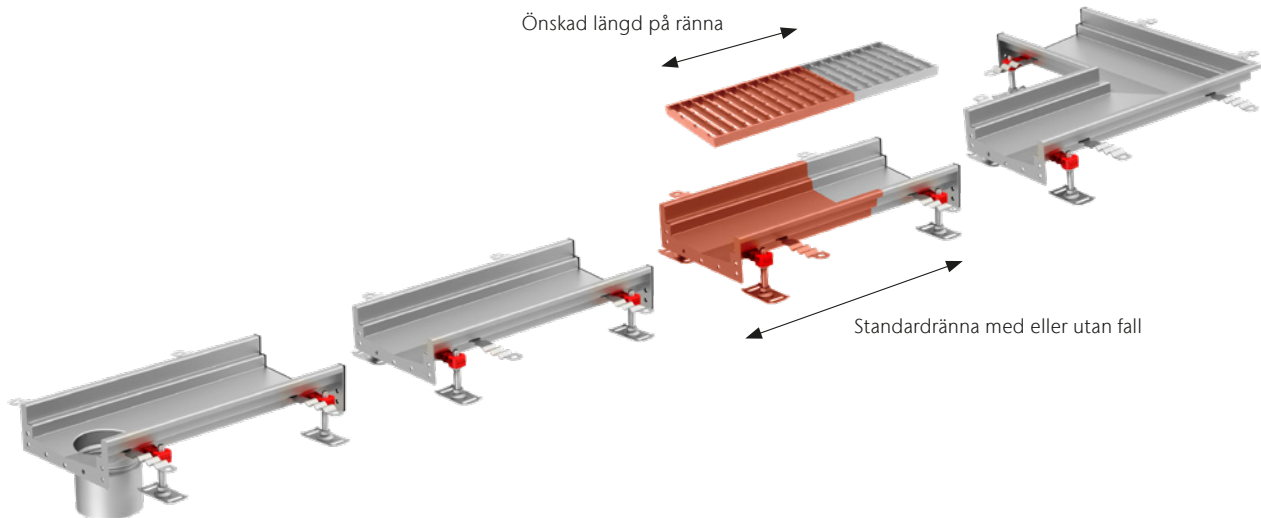

Beskriv den önskade längden på rännan. (Längden utgår alltid från lägsta höjd om du önskar en speciallängd med fall)

ACO. we care for water

Egendesignat galler

ACO ger dig möjlighet att vara kreativ och designa ditt egna galler. Gallrets utformning kan förstärka företagets identitet genom att låta gallrets mönster vara en del av logotypen eller anpassas efter fastighetens arkitektur. Möjligheterna är många.

Om man vill förstärka sitt varumärke ytterligare finns möjligheten att laser-gravera gallret med logotyp eller valfritt budskap.

Hur går det till?

För att kunna framställa specialdesignade galler behöver underlaget vara en CAD-fil (.dwg eller liknande). Kontakta oss på ACO innan arbetet påbörjas för råd och tips.

Hur beställer man ett specialanpassat galler?

Kontakta oss på ACO så hjälper vi till.

Telefon: 031-338 97 00
info@aco-nordic.se



Alla produkter från ACO Nordic
bidrar till framtidens klimatmål.
Vi kallar det ACO WaterCycle.



-
- Linjeavvattning
 - Oljeavskiljare
 - Fettavskiljare
 - Slamavskiljare
 - Tekniska filter
 - Pumpstationer
 - Flödesreglering
 - Fördröjningsmagasin
 - Sedimentering
 - Bakvattenventiler
 - Rostfria rör och brunnar
 - Amfibieskydd
 - Regnvattenåtervinning
 - Sport och fritid
-

ACO Nordic AB

Huvudkontor

Industrivägen 4
433 61 Sävedalen
Tel. 031-338 97 00

info@aco-nordic.se
www.aco-nordic.se

ACO. we care for water

