

Förklaringar

Alla mått i millimeter

Dimensioner avrundade till närmsta hela mm

- A Lock (med betongfyllning)
- B Tätningring
- C Låsskruv
- D Betongfyllning

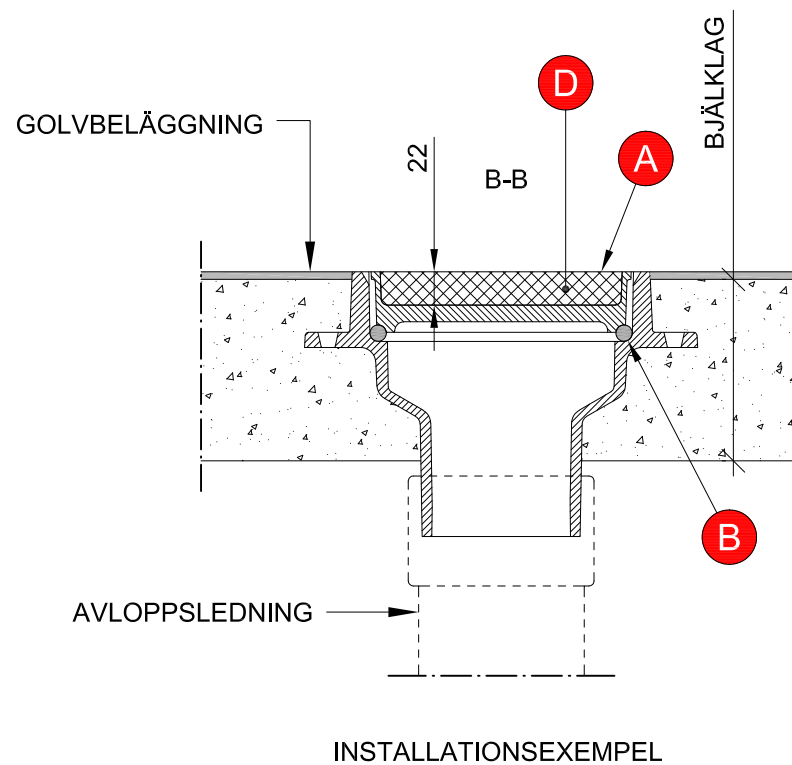
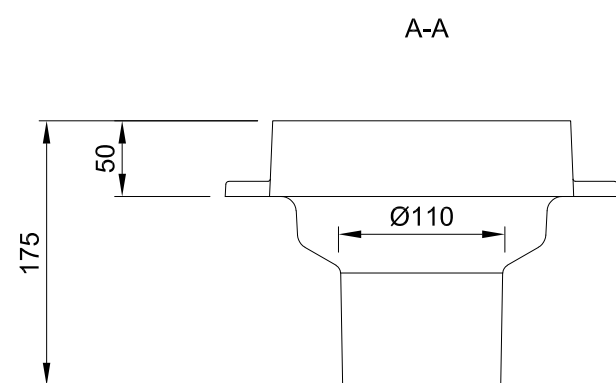
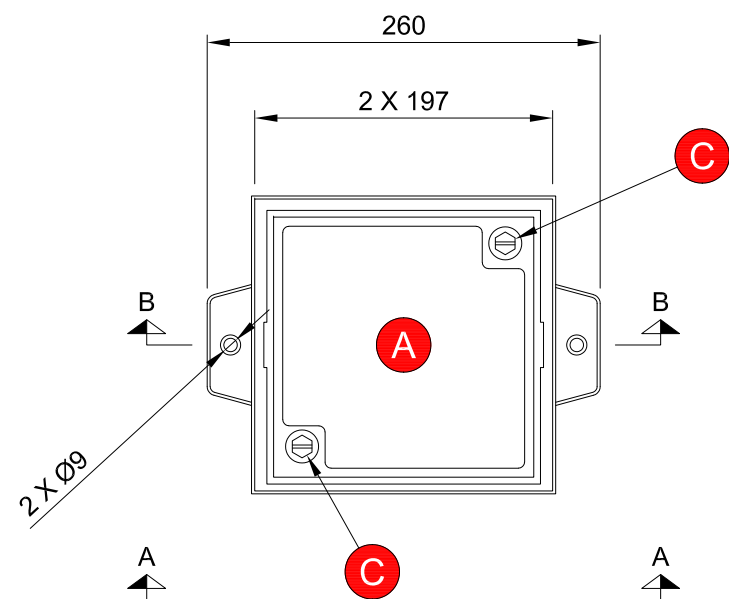

Egenskaper

Material	Gjutjärn
Belastningsklass	M125
Korrosiviteitsklass	C2



ACO Nordic AB
 Industrivägen 4
 433 61 Sävedalen
 www.aco-nordic.se

Produkt

Jack-In Finor F3
 (RSK-nummer: 714 92 25)

Skala
 1:5 (A3)

Ritning
 2D

Millimeter

